

AVK-1000 Automatic Vacuum Mass Comparator

Vacuum comparison with the highest accuracy



AVK-1000



LOAD LOCK - Switching and adding artefacts without opening of the main chamber



6-position magazine



Switching and adding artefacts without opening of the main chamber'



Suspended weighing pan of custom design eliminating eccentricity errors

Functions

-  Mass comparator
-  Ambient conditions measurement
-  Proximity sensors
-  Replaceable units
-  Multilingual menu

Features

Effective and Excellent Measurement

Resolution of 10 billion units plus elimination of human error and other external factors due to the use of vacuum chamber effectively prevent any potential errors that may occur during the measurement.

Mass Standard Maintenance

The AVK-1000 automatic vacuum mass comparator is intended for national metrological institutes that transport and maintain the national reference mass standard of 1 kg.

Vacuum Chamber Measurement

A specially designed vacuum chamber enables carrying out measurements in a vacuum of 10^{-6} mBar capacity or in atmosphere containing noble gases.

Excellent Measurement Accuracy

The comparator enables comparison of up to 6 objects of cylinder or sphere shape, each of them of max 1 kg mass, with repeatability of 0.3 μ g and readability of 0.1 μ g. Use of the suspended weighing pan eliminates the influence of eccentric mass standards loading.







LOAD LOCK

The LOAD LOCK system for carrying mass standards enables switching and adding artefacts without changing the atmosphere inside the main chamber. The LOAD LOCK is equipped with a high-efficiency pump system, the time of pumping the air out in order to enable opening of the valve of the main chamber is significantly shortened. The stabilization of the main chamber after replacing/adding the mass standard and closing the valve connecting the main chamber and the LOAD LOCK system takes 5 hours. It enables switching objects of dimensions adapted to the AVK-1000 mass comparator: cylindrical mass standards of 22-95 mm diameter and silicone spheres of 40-100 mm diameter.

Ambient Conditions Monitoring

The AVK-1000 automatic mass comparator is equipped with a vacuum gauge and a thermo-hygro-barameter which enables ambient conditions monitoring to be carried out with very high accuracy (0.001 hPa for pressure, 0.01% for humidity and 0.001 $^{\circ}$ C for temperature).

Technical Specifications

		AVK- 1000
OIML calibration range E1		100 g ÷ 1 kg
OIML calibration range E2		100 g ÷ 1 kg
OIML calibration range F1		100 g ÷ 1 kg
OIML calibration range F2		100 g ÷ 1 kg
OIML calibration range M1		—
OIML calibration range M2		—
Maximum capacity [Max]		1002 g
Readability [d]		0.1 µg
Repeatability for nominal load*		0.5 µg
Stabilization time		60 s
Adjustment		external
Electric compensation range		-1 g ÷ + 2 g
External supplementary weights		500 g; 800 g; 900 g
Comparison object dimensions		cylindrical ø (22-95) × 110 mm; spherical ø (40-100) mm
Magazine positions		6
Display		5.7" colour resistive touch screen
Keypad		8 keys
Ingress protection - indicator		IP 43
Touch-free operation		2 programmable sensors
USB-A		2
Ethernet		10 / 100 Mbit
RS 232		2
Wireless Connection		802.11 b/g/n
IN/OUT		4 × IN, 4 × OUT
Power supply		110 ÷ 230 V AC / 50 ÷ 60 Hz
Operating temperature		+15 ÷ +30 °C
Operating temperature change rate		±0.1 °C / 12 h
Pressure in the vacuum chamber		10 ⁻⁶ mBar
Relative humidity***		45 ÷ 60%
Transport and storage temperature		-20 ÷ +50 °C
Weighing pan dimensions		ø 100 mm
Indicator dimensions**		206 × 140 × 70 mm
Mass comparator dimensions**		1025 × 2600 × 1080 mm
Net weight		800 kg (including weighing table mass)
Gross weight		1043 kg (including weighing table mass)
Vacuum chamber packaging dimensions****		1200 × 860 × 1320 mm
Frame and accessories packaging dimensions****		1200 × 860 × 1100 mm
Stone packaging dimensions****		1200 × 860 × 420 mm

* repeatability in vacuum for model ambient conditions

** dimensions: length x width x depth

*** non-condensing conditions

**** the shipment consists of three packages

Dimensions

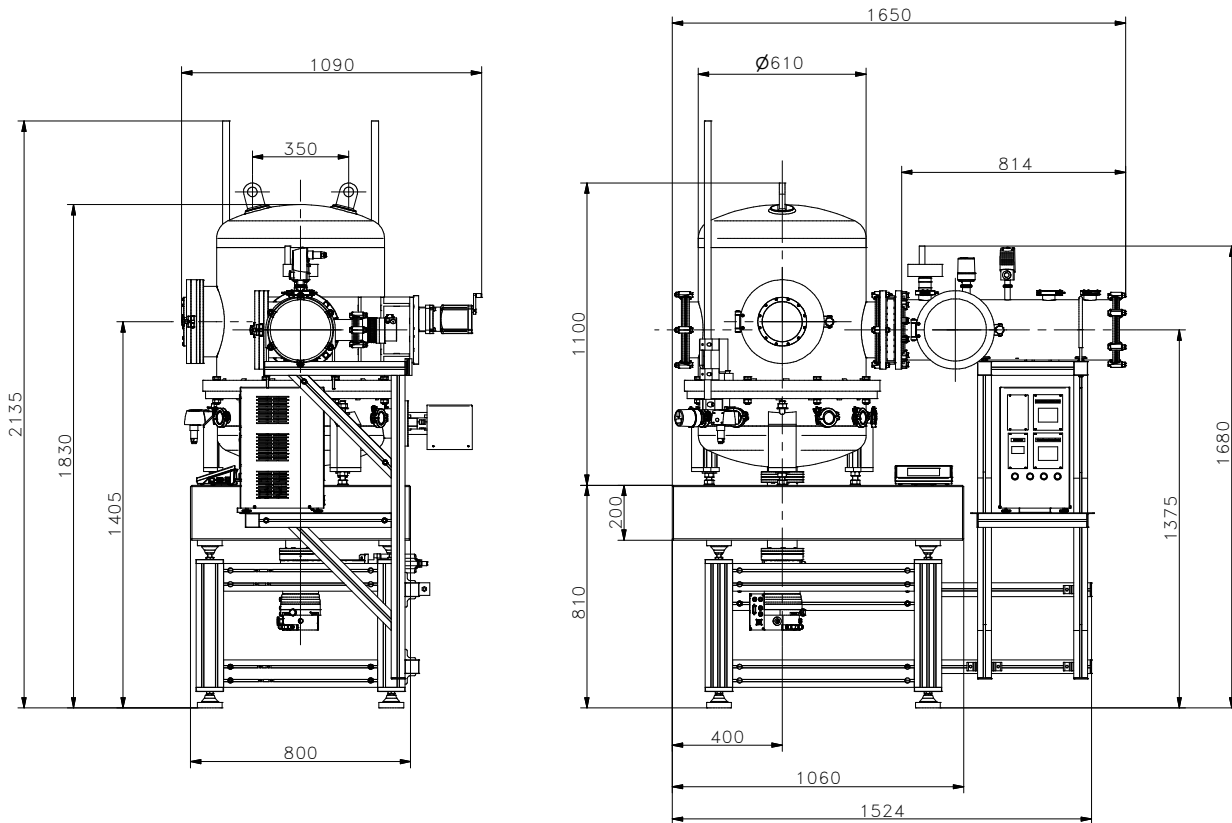

AVK-1000

Accessories

Peripheral Devices

- Epson dot matrix printer
- barcode scanner
- WD-5/3Y LCD display (backlit)

Cables, Converters

- RS-232 – P0108 computer cable
- RS-232 – P0167 computer cable

- RS-232 – P0151 Epson printer cable

Electrical Accessories

- power supply with ZR-02 battery

Remaining Accessories

- load locker
- lift

Dedicated Software

RMCS System

- performance of calibration procedures in a laboratory from the moment the order is placed, to the moment of issuing a calibration certificate
- compatible with THB sensors enabling recording ambient conditions
- export of report results to various files
- archiving calibration protocols, orders, certificates and ambient conditions

RADWAG Remote Desktop

- remote control of the mass comparator using computer, telephone or tablet
- sending text messages
- version for Windows 10 and Android systems

R-LAB

- collecting measurements
- carrying out statistical analysis of measurements
- customized graphs and reports

Parameters Editor

- remote change of parameters
- remote on-line preview of the display
- displaying current mass indication
- software update
- file loading, editing and saving parameters to a file
- import and export of parameters
- interfaces: RS232, Ethernet and Wireless Connection
- quick and easy edition of balance parameters using computer