

Thermo Scientific AquaSensors DataStick

Toroidal conductivity measurement system

Thermo Scientific™ AquaSensors DataStick measurement system for universal plug & play.

Markets/Applications

- Chemical production
 - Leak detection in heat exchangers
 - Acid and caustic dilution
- Metal finishing
 - Plating bath control
 - Parts cleaning & rinsing
 - Pickling bath control
 - Waste streams
- Semiconductors
- Pulp & paper
 - Black, white, or green liquor
 - Pulp bleaching
- Food processing
 - Chemical peeling
 - Sanitization (CIP)
- Pharmaceutical
 - Chemical concentration control
- Environmental
 - Wet chemical scrubbers
 - Cooling towers



Thermo Scientific™ AquaSensors Toroidal Conductivity DataStick™

- High resolution measurement
- Pre-calibrated (no field calibration required)
- Plug & play sensor heads
- 0 to 2 S/cm range
- Offered in a variety of materials
- Direct data reporting (24-bit)
- Plug & play industrial communications adapters

Connect this toroidal conductivity sensor directly to a PLC (Programmable Logic Controller) for seamless integration with industrial control systems.

Use any computer to display data, calibrate and customize the measurement without an intermediate analyzer electronics box. Sensor heads are pre-calibrated and can be replaced or exchanged with any other type of sensor without taking the system down. Save space, time and money.

DataStick provides universal conversion of sensor signals and interactive communications for measurement, calibration, configuration and diagnostics.

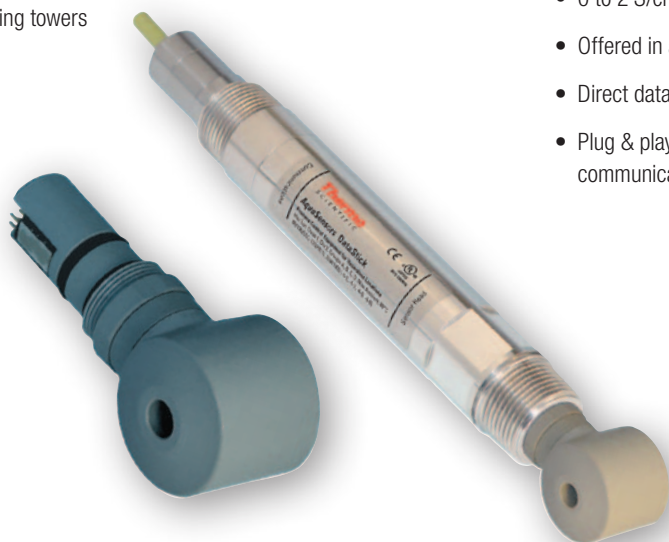

Thermo
SCIENTIFIC

Engineering Specifications

- The toroidal conductivity sensor shall have a diameter of 1.5 inches. It will have 1 $\mu\text{S}/\text{cm}$ resolution and will measure up to 2 S/cm at 25 °C. The sensor body will have a tightly controlled wall thickness to prevent cracking with heating and cooling cycles.
- The sensor shall have hex-shaped wrench flats to facilitate mounting, and shall be constructed of a material with exceptional chemical resistance and mechanical strength. This material shall enable the sensor to be installed in metal fittings without leakage usually caused by heating and cooling cycles when dissimilar materials are threaded together.
- The sensor shall have interchangeable, pre-calibrated plug-in sensor heads and communications adapters that can be installed without powering down the system.
- The sensor shall have 1 inch NPT threads on both ends to mount into a standard 2 inch union mounting, a sanitary tee, 2 inch ball valve or immersion hardware.
- The built-in electronics of the sensor shall be completely encapsulated and O-ring sealed for protection from moisture and humidity.
- The sensor shall have a built-in pre-amplifier, universal signal conditioning electronics, universal engineering units conversion, and interactive communications with a host computer or display interface using one of several protocols including Modbus® RTU, DeviceNet™, PROFIBUS™, USB, CANopen or Ethernet.
- The sensor shall have an integral temperature sensor to automatically compensate measured values for changes in process temperature.
- The sensor shall be Thermo Scientific AquaSensors Toroidal Conductivity DataStick.

Thermo Scientific DataStick Analytical System

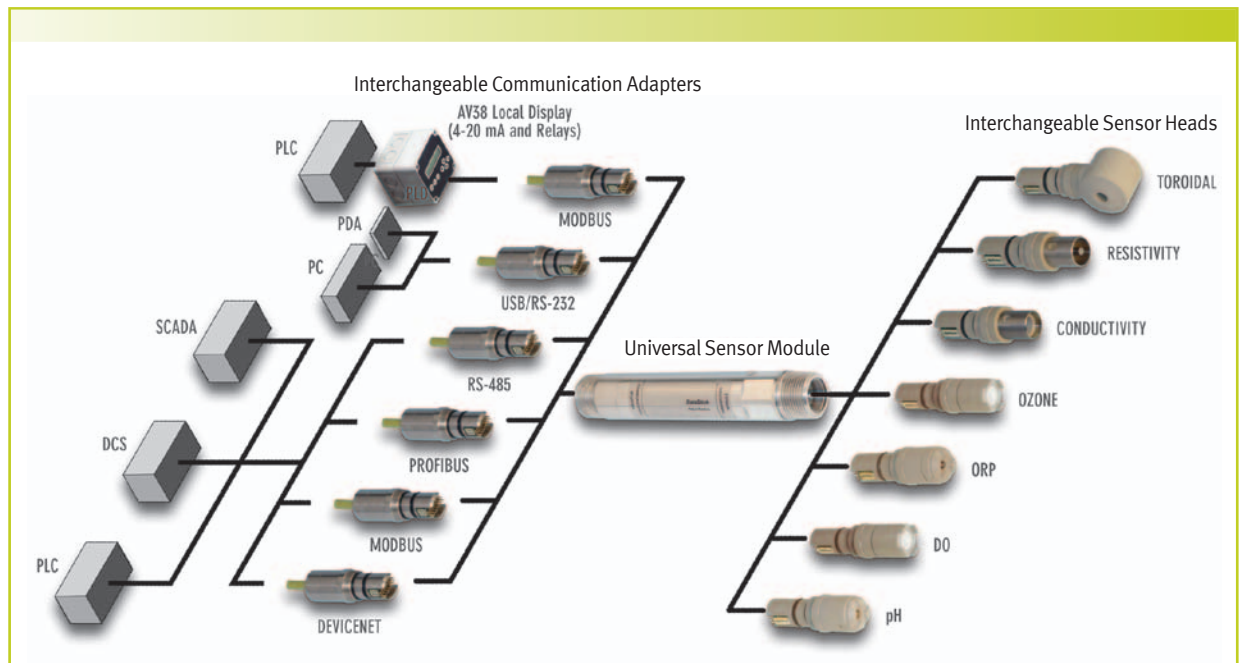

Key Components

DataStick

Provides universal conversion of sensor signals and interactive communications for measurement, calibration, configuration and diagnostics.



Toroidal Conductivity Sensor Head

Pre-calibrated for conductivity and temperature. Can be plugged into any DataStick to yield accurate 24-bit data.

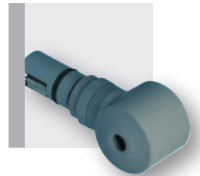

Communications Adapter

Plugs into the DataStick to provide power and direct interactive communications with control systems.



AV38 Local Display/Controller

2 line display and 7 key navigation. Data reporting with up to 2 current outputs. 2 Form C relays. Digital communications.

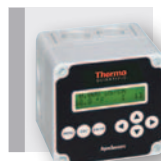

Thermo Scientific AquaSensors Toroidal Conductivity DataStick

Mounting adapters, junction boxes and recharge kits are available.

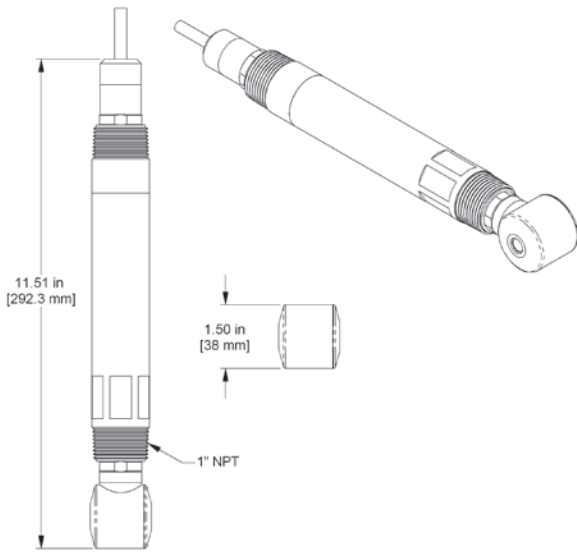

Specifications	
Measurement System Performance[†]	Range: 0 to 2,000,000 $\mu\text{S}/\text{cm}$ (2 S/cm) Resolution: 4.5 significant digits Accuracy: 0.1 % of reading Step Response Time: 90 % in 30 seconds
Operational Environment	PEEK Sensor Head Temperature Range: -5 °C to 100 °C Maximum Pressure: 200 psig @ 100 °C Maximum Flow Rate: 10 ft/second CPVC Sensor Head Temperature Range: -5 °C to 75 °C Maximum Pressure: 85 psig @ 75 °C Maximum Flow Rate: 10 ft/second
Power Requirements[‡]	Voltage Range: 10 to 30 VDC Maximum Power: 200 mW Typical Power: 120 mW
Construction	O-rings: Viton [®] (other materials available) Sensor Head Material: CPVC, PEEK Weight: 1.2 lbs (PEEK or CPVC) ; 2.6 lbs (316 stainless steel)
Units Of Measure	Measurement Units: $\mu\text{S}/\text{cm}$, TDS, % conc. Temperature Units: °C, °F
Calibration^{††}	Zero: In dry point Span: 1 point Temperature: 1 point
Temperature Compensation Options^{‡‡}	Linear: % per °C
Other Configuration Options	Sensor Filter: 0 to 100 seconds Temperature Filter: 0 to 100 seconds Concentration Table: User 10-point
Approvals And Ratings	Immunity & Emissions: CE certified 89/336/EEC: CISPER 11, EN61000 (-4-2, -4-3, -4-4, -4-6, 4-8) Safety: cULus listed; 367G E303570 Hazardous Locations: Haz Loc Class 1, Division 2, Groups A, B, C, D. Max ambient 80 °C

[†] Note: Typical at 25 °C performance unaffected by cable length

[‡] Note: Class II DC power supply required

^{††}Note: Toroidal are pre-calibrated at the factory

^{‡‡}Note: Temperature can be entered manually

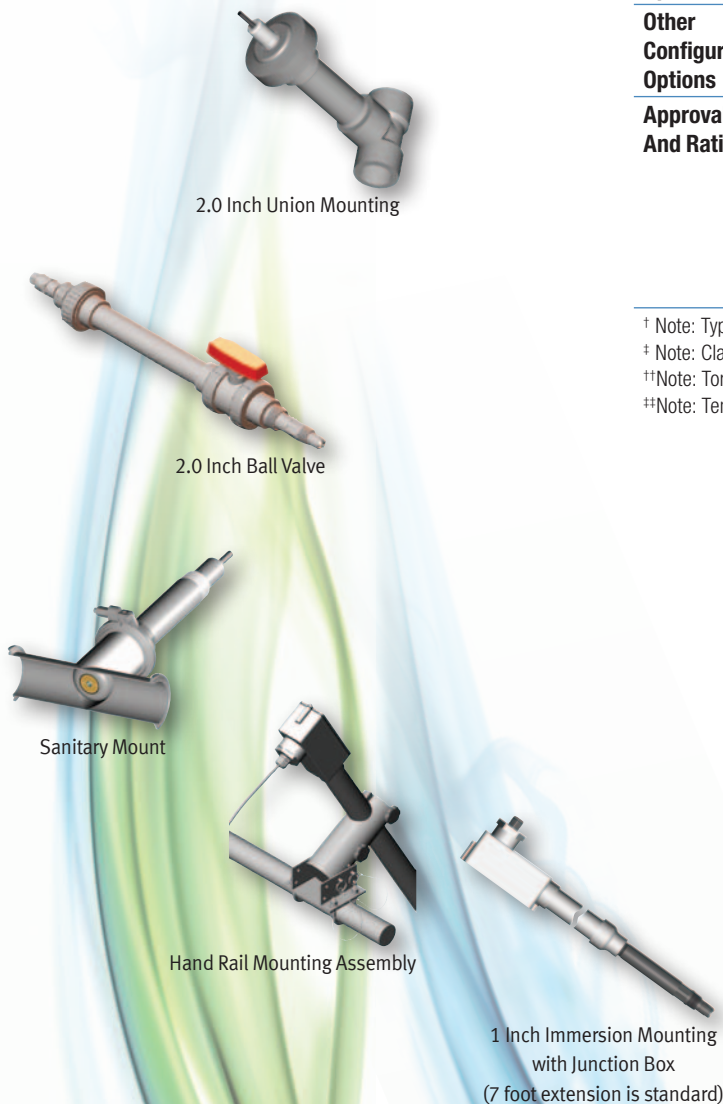

2.0 Inch Union Mounting

2.0 Inch Ball Valve

Sanitary Mount

Hand Rail Mounting Assembly

1 Inch Immersion Mounting
with Junction Box
(7 foot extension is standard)

Thermo Scientific AquaSensors Toroidal Conductivity DataStick

- **Global support**—with experience that comes from supporting our customers for over 35 years throughout the world, our water quality specialists and customer support teams offer a quick, thorough and professional response to any problem encountered.
- **Focus on user benefits**—we work closely with you to define your needs, and ensure you are using the monitor in a way that improves your bottom line. For more information, contact your local water quality specialists or visit: www.thermoscientific.com/processwater.

Toroidal Conductivity DataStick Ordering Information

Part No.	Description
DS-b-t	DataStick
Body Material (b)	1 = 316 stainless steel 2 = CPVC 3 = PEEK
Mounting (t)	1 = NPT front/back 2 = 1 inch NPT front only 4 = 2 inch tri-clamp 5 = 2.5 inch tri-clamp
TC-b	DataStick
Body Material (b)	2 = CPVC 3 = PEEK
CA-b-nw-x-y	Communications Adapter
Body Material (b)	1 = 316 stainless steel 2 = CPVC 3 = PEEK
Communications (nw)	1A = RS232 ASCII 2B = Modbus RTU 2A = Modbus RS232 4B = CANopen 7R = Ethernet 5R = DeviceNet 8R = USB
Cable Length (x)	1 = 10 feet 2 = 20 feet 3 = 30 feet
Cable Termination (y)	A = Stripped wires

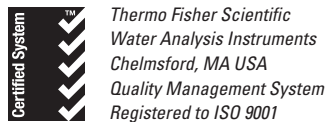

thermoscientific.com/processwater

© 2013 Thermo Fisher Scientific Inc. All rights reserved. Modbus is a registered trademark of Schneider Electric. DeviceNet is a trademark of ODVA. PROFIBUS is a trademark of PROFIBUS Nutzerorganisation e.V. Viton is a registered trademark of E. I. Du Pont De Nemours & Company. All other trademarks are the property of Thermo Fisher Scientific Inc. and its subsidiaries.

Accessories Ordering Information

Part No.	Description
Conductivity Solutions, 500 mL Bottles	
SOL1000	1000 µS/cm calibration solution
SOL2000	2000 µS/cm calibration solution
SOL5000	5000 µS/cm calibration solution
Mounting Hardware	
MH1032	2 inch union mount, CPVC
MH1031	2 inch union mount, 316 SS
MH1032	2 inch ball valve, CPVC, low pressure
MH1172	2 inch ball valve, 316 SS, low pressure
MH1171	2 inch ball valve, CPVC, high pressure
MH1182	2 inch ball valve, 316 SS, high pressure
MH1242	Hand rail mounting assembly, swivel/immersion, PVC
MH3083	1 inch immersion mounting with junction box, PVC (7 foot extension is standard)

Consult factory for additional configurations and accessories.

Water Analysis Instruments

North America
Toll Free: 1-800-225-1480
Tel: 1-978-232-6000
info.water@thermo.com

Netherlands
Tel: (31) 033-2463887
info.water.uk@thermo.com

China
Tel: (86) 21-68654588
wai.asia@thermofisher.com

India
Tel: (91) 22-4157-8800
wai.asia@thermofisher.com

Singapore
Tel: (65) 6778-6876
wai.asia@thermofisher.com

Japan
Tel: (81) 045-453-9175
wai.asia@thermofisher.com

Australia
Tel: (613) 9757-4300
in Australia (1300) 735-295
InfoWaterAU@thermofisher.com



Thermo
SCIENTIFIC

Part of Thermo Fisher Scientific